



# WORLD DEFENSE SHOW

SAUDI ARABIA  
6-9 MARCH 2022

FOUNDED BY



الهيئة العامة للصناعات العسكرية  
General Authority for Military Industries

# Sales Brochure

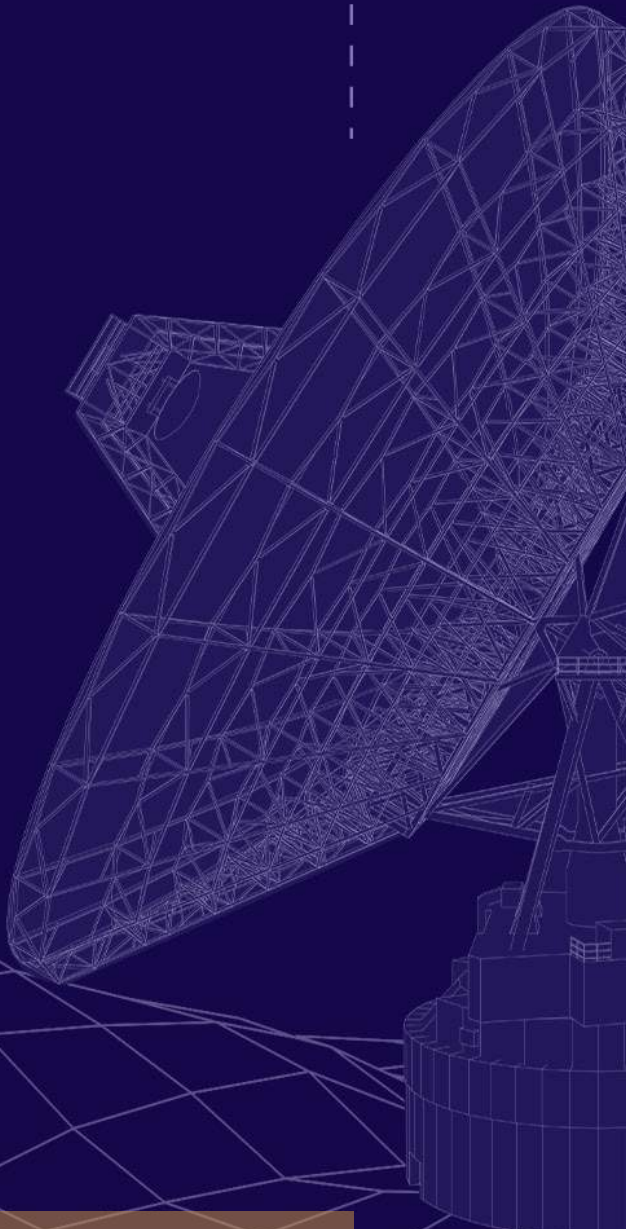
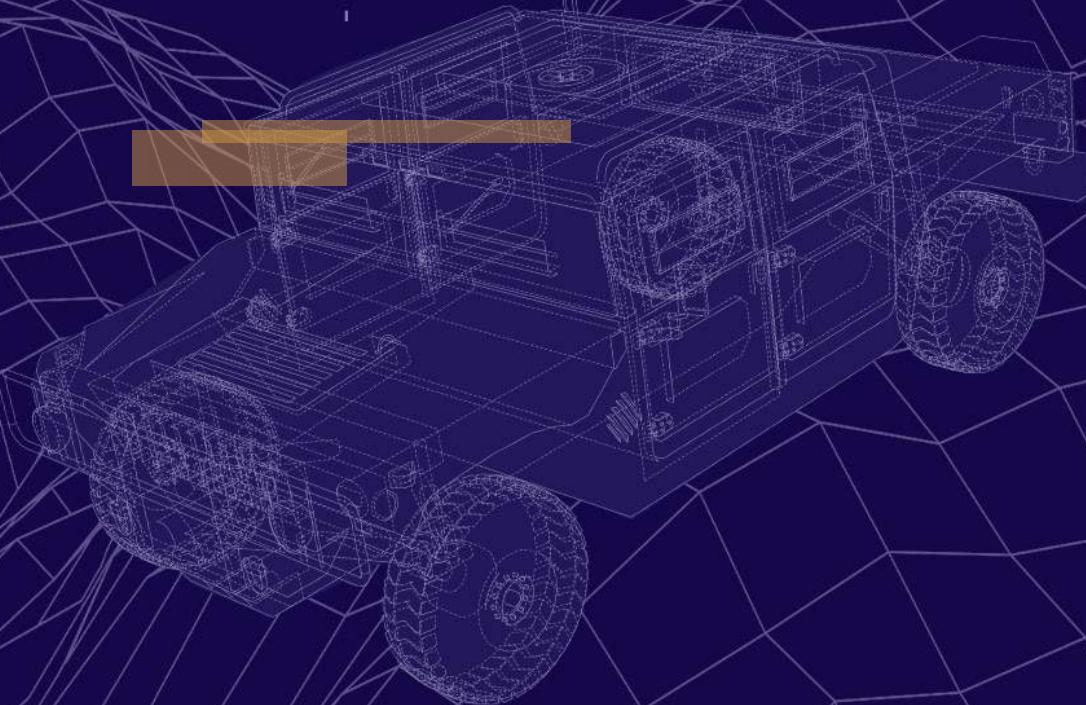
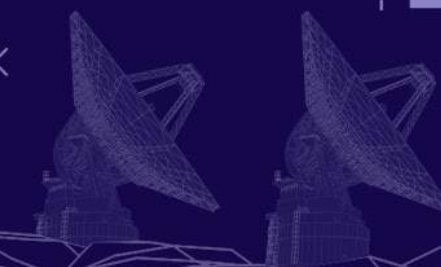
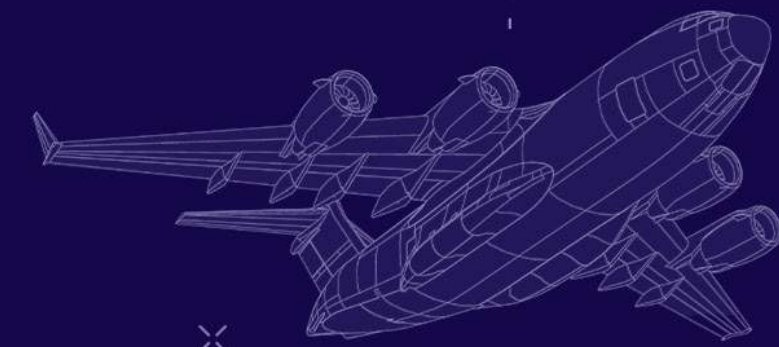



# Contents

- Welcome Note** \_\_\_\_\_ **03**
- The Show At A Glance** \_\_\_\_\_ **04**
  - Facts \_\_\_\_\_ **05**
  - Show Features \_\_\_\_\_ **06**
  - Show Offerings \_\_\_\_\_ **07**
- Exhibitor Benefits** \_\_\_\_\_ **08**
  - Connection & Collaboration \_\_\_\_\_ **09**
  - Conferences & Seminars \_\_\_\_\_ **11**

- Heart Of The Global Supply Chain \_\_\_\_\_ **12**
- Interoperability \_\_\_\_\_ **13**
- Hub Of Trade \_\_\_\_\_ **15**
- Saudi Arabia’s Ecosystem \_\_\_\_\_ **16**
- How To Participate** \_\_\_\_\_ **18**
  - Exhibiting Options \_\_\_\_\_ **19**
  - Sponsorship Options \_\_\_\_\_ **23**
  - Contact Details \_\_\_\_\_ **24**



Governor of General Authority for Military Industries  
**His Excellency Ahmad Al-Ohali**

**World Defense Show comes at an opportune time, both for the Kingdom of Saudi Arabia and the global defense industry. With the aim to serve as the global platform for the future of defense interoperability, the show aligns with Saudi Arabia's Vision 2030 target to leverage defense spending and industrialize its defense sector.**

Focused on innovation, future technology and interactivity, World Defense Show provides a unique experience, through interactive displays and demonstrations of defense solutions, across air, land, sea, satellite, security systems and more; changing the way global leaders and decision makers approach integrated defense capabilities.

Investment is a critical instigator of change. We need to ensure that we are collaborating to address tomorrow's defense challenges and directing investments towards disruptive ideas and defense tech start-ups that will shape the industry's future. World Defense Show will create and catalyze such opportunities. Ultimately, the show will be a reflection of the size of opportunities and value of partnerships available, putting Saudi Arabia at the heart of a more collaborative global defense industry.

**We look forward to welcoming you to Riyadh, in March 2022, as we embark on a journey of discovery in this promising industry.**

**Ahmad Abdulaziz Al-Ohali**  
Governor, General Authority for Military Industries

The background features a complex technical wireframe in light blue, consisting of various geometric shapes like spheres, cylinders, and rectangular frames. Overlaid on this are several solid-colored shapes: a large orange curved shape on the left, a vertical orange bar, and a blue arrow pointing upwards and to the right. The text is centered in a bold, dark blue font.

# The Show At A Glance

# The Global Stage For Defense Interoperability

4

Trade Days

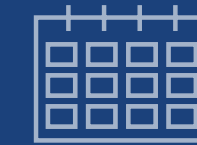

5

Defense Domains



800+

Exhibitors



45+

Countries



15+

International Pavilions



85+

Military Delegations



80k+

Trade Visitors



3k+

International Industry VIPs



2k+

Students



600+

Media



Estimated event statistics

# Show Features

## Gain International Exposure

Over 45 countries are expected to participate in the show, including emerging exporters and KSA military partners spread over 15 country pavilions. As an exhibitor, you will have the opportunity to participate in World Defense Show's invite-only opening ceremony and various networking functions in the evenings. Your business will also be eligible to participate in the Official Military Delegations Program, comprising of over 80 delegations and set to provide you with the most engaging experience the defense show circuit has to offer.

### See the future of defense

Your business can be featured among a full spectrum of defense product segments in our innovative hubs. With a special focus on innovation and technology, our hubs will showcase state of the art technologies and unique products;

- Industry 4.0
- Start-ups
- Biodefense
- Unmanned Systems
- Urban Air Mobility
- Satellites
- Rotary

### Invest in the future of defense

Take your business to the next level by showcasing and engaging with advanced defense applications at the horizon of the defense and security sector, increasingly taking share of global defense spend;

- Advanced Ballistics
- Advanced C5ISR Solutions
- Soldier of the Future
- Advanced Weaponry
- Advanced Space Systems
- Unmanned Systems
- Enhanced Platforms
- Cyber Defense
- Electronic Warfare
- Simulated Training

### Experience the future of defense

Live military equipment demonstrations and comprehensive product displays will offer you an unrivalled experience, witnessing new products and concepts across the world of defense work in harmony with one another;

- Interoperability
- Naval Systems
- Security Systems
- Swarm Technology
- Advanced Manufacturing Technology
- Advanced Defense Technology
- Military Airshows



# Fully Integrated Product Segments

World Defense Show's fully integrated exhibition covers a broad range of product segments; end systems, sub-systems and components aligned to global and domestic defense requirements.

## End Systems

- Land Systems
- Air Systems
- Naval Systems
- Satellite Systems
- Homeland Security Systems
- Cyber Security Systems

## Sub-Systems & Components

- Sub-Systems
- Communication & Information
- Unmanned Systems
- Weapons & Ammunition
- Infrastructure & Installation
- Medical & Emergency
- Training & Simulations
- Personal Equipment
- R&D
- Services & MRO
- Advanced Manufacturing Technologies

The background features a complex technical drawing or blueprint in light blue and grey lines, overlaid with a large, thick orange question mark on the left side. The text is positioned on the right side of the image.

# Exhibitor Benefits



## Official Military Delegations Program

Meet your business goals and ambitions by networking with the industry's key military decision makers - included for all exhibitors as part of your participation package.

## Meet The KSA Government Program

Introducing you to the vision of the Kingdom; learn about Saudi Arabia's latest developments and opportunities to get involved.

# Networking



## Supply Chain Program

Discover what the international OEM buyers and supply chain has to offer your business as you engage with global industry peers and sector leaders to expand your presence.

## Investor-Investee Program

Engage with start-up companies at the forefront of innovation across the latest technologies, witness the next generation of defense products and discover investment opportunities to take your business to the next level.

## Future Talent Program

Meet the up-and-coming future industry talent, demonstrate career opportunities in your business and showcase apprenticeship programs.



## Industry-wide Connections & Collaboration

With exhibitors from across the globe, World Defense Show will cover capabilities across the entire defense value chain. In turn, the show is set to offer you unprecedented networking opportunities and engagement programs.

Attended by a global audience, World Defense Show will see high profile attendees; key military, industry and government decision makers, Royals, VIPs, Heads of State, and senior executives.

Tailored networking programs will serve to support Saudi Arabia's national agenda by promoting local business, featuring industry talent and offering education opportunities while helping you make the most out of your visit.

# Thought Leading Conferences, Panel Discussions & Seminars

Participate in thought leadership conferences and seminars as World Defense Show tackles some of the most critical challenges and questions facing the global defense industry. As a participant, you will have the opportunity to engage, learn and share knowledge with world-renowned industry experts, keynote speakers and thought leaders;

- Pre-show conferences on pertinent global topics
- Panels and presentations on emerging trends, concepts and new products
- Brand-specific press conferences announcing the latest industry developments
- Product reveal announcements on key innovations and new products to help transform and interconnect, all defense and security domains





# Exhibit In The Heart Of The Global Defense Supply Chain

**Saudi Arabia is one of the world's leading defense players and continues to rank among the sector's top spenders. At the heart of the global supply chain, Saudi Arabia connects three continents, where East meets West, making it an ideal location to host World Defense Show.**

In line with the economic reform that Vision 2030 outlines, Saudi Arabia is rebalancing defense spending by increasing localization to 50% of military spending by 2030, drastically expanding the defense ecosystem of SMEs and international partnerships, reinforcing its role as a global defense hub for multinational businesses.



# Invest In The Future Of Defense Innovation & Interoperability



**The defense world will hugely benefit from Saudi Arabia, one of its biggest influencers and spenders, contributing and shaping where global defense is heading. At a time when data and security have become the world's strongest currencies, Saudi Arabia is taking a more active role, driving innovation, investing in change and helping to shape the future of defense.**

# Experience Saudi Arabia's history of trade and rich culture of hospitality

**World Defense Show will be hosted in the birthplace of modern Saudi Arabia, Riyadh – a metropolis with a thriving financial and business center, and a growing cultural scene. Riyadh has a textured and colorful history, housing some of the country's most iconic souks, palaces and forts.**

Saudi Arabia's heritage and traditions have been shaped by its position as a historic trade hub. Millions of tourists and pilgrims visit the Kingdom every year. In addition to the holy cities of Makkah and Medina, a myriad of ancient cultural destinations, heritage artifacts, outdoor activities and local delicacies await you to discover. In recent years, the Kingdom has undergone a significant cultural transformation, evolving century-old customs to fit into the contemporary world of today.

The show's exciting estimated 800,000 sqm venue will offer the space and facilities required for the ambition of the agenda and to host esteemed guests and delegates in an environment fitting of the occasion. The exhibition area will use interactive technologies for product displays, simulations, live demonstrations and engaging conferences and seminars on an unprecedented scale.



# Explore Saudi Arabia's Defense Ecosystem

**World Defense Show strongly supports the development and growth of Saudi Arabia's defense sector. Discover and uncover opportunities for your business in the strategic defense hub of the region as the Kingdom's defense capabilities are featured and showcased on an unprecedented scale.**



# 30%



**Share of exhibition space**  
for local Saudi defense and  
supply chain companies

# 40+

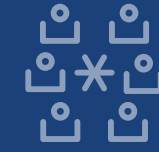

**Key Saudi government  
stakeholders including,**  
Armed Forces of Saudi  
Arabia, ministries and  
investment authorities

# 100+



**Local defense companies,**  
government entities,  
holding companies and  
family owned businesses

# 80+



**Pre-scheduled meetings with KSA  
government officials**  
under the Meet the KSA Government  
Program

# 600+



**Pre-scheduled meetings between  
defense companies and local SME'**  
through the Supply Chain Program

# 2k+



**Local students to interact  
with defense companies**  
during Future Talent Program  
sessions and meetings

# 30+



**Local Saudi knowledge  
providers across**  
universities, R&D centers  
and relevant institutes

# 8+



**Conferences on KSA defense  
industry and localization**  
of military spending as part  
of Vision 2030 mandate

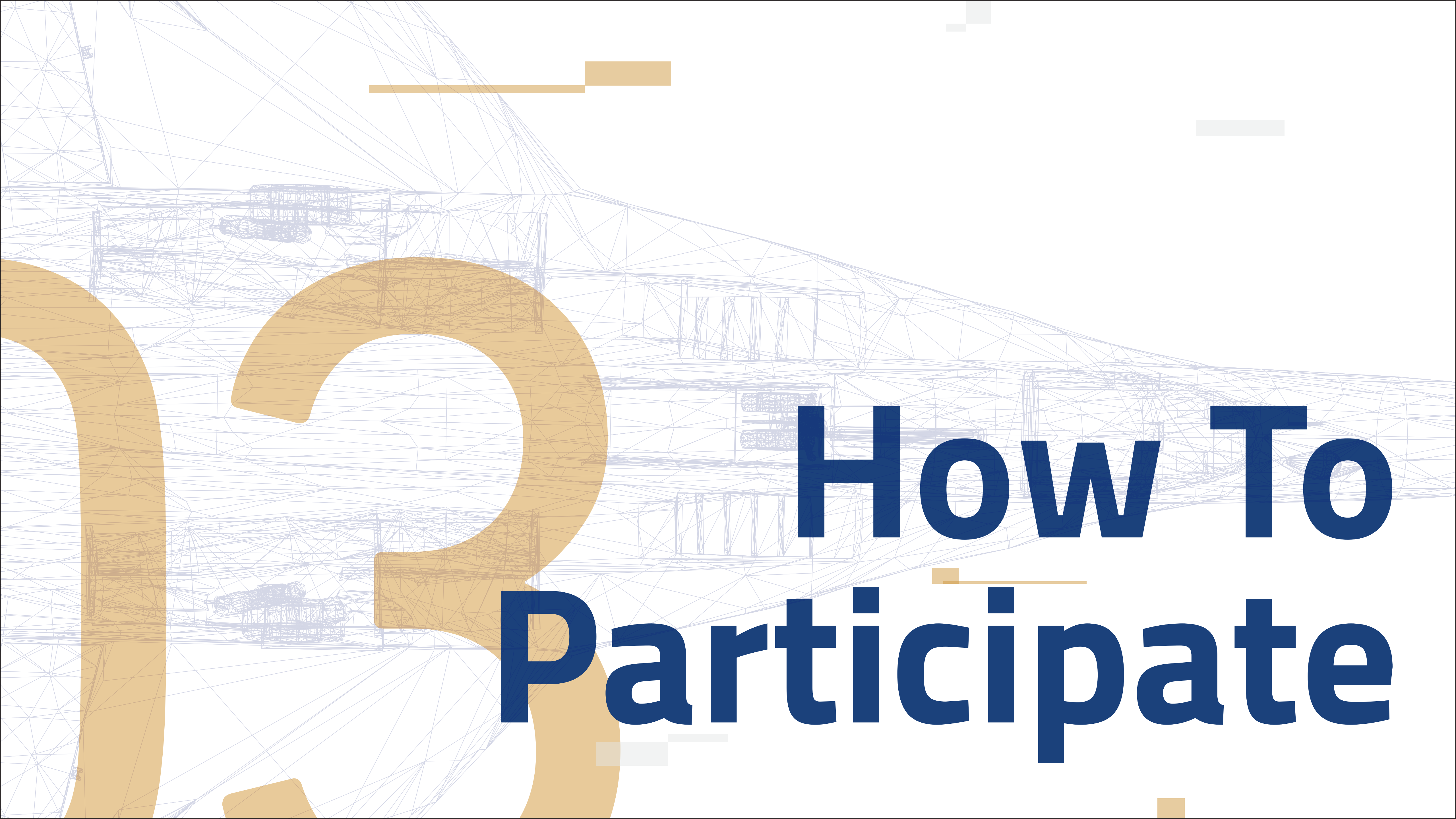

# How To Participate

# Be a part of the future of Defense

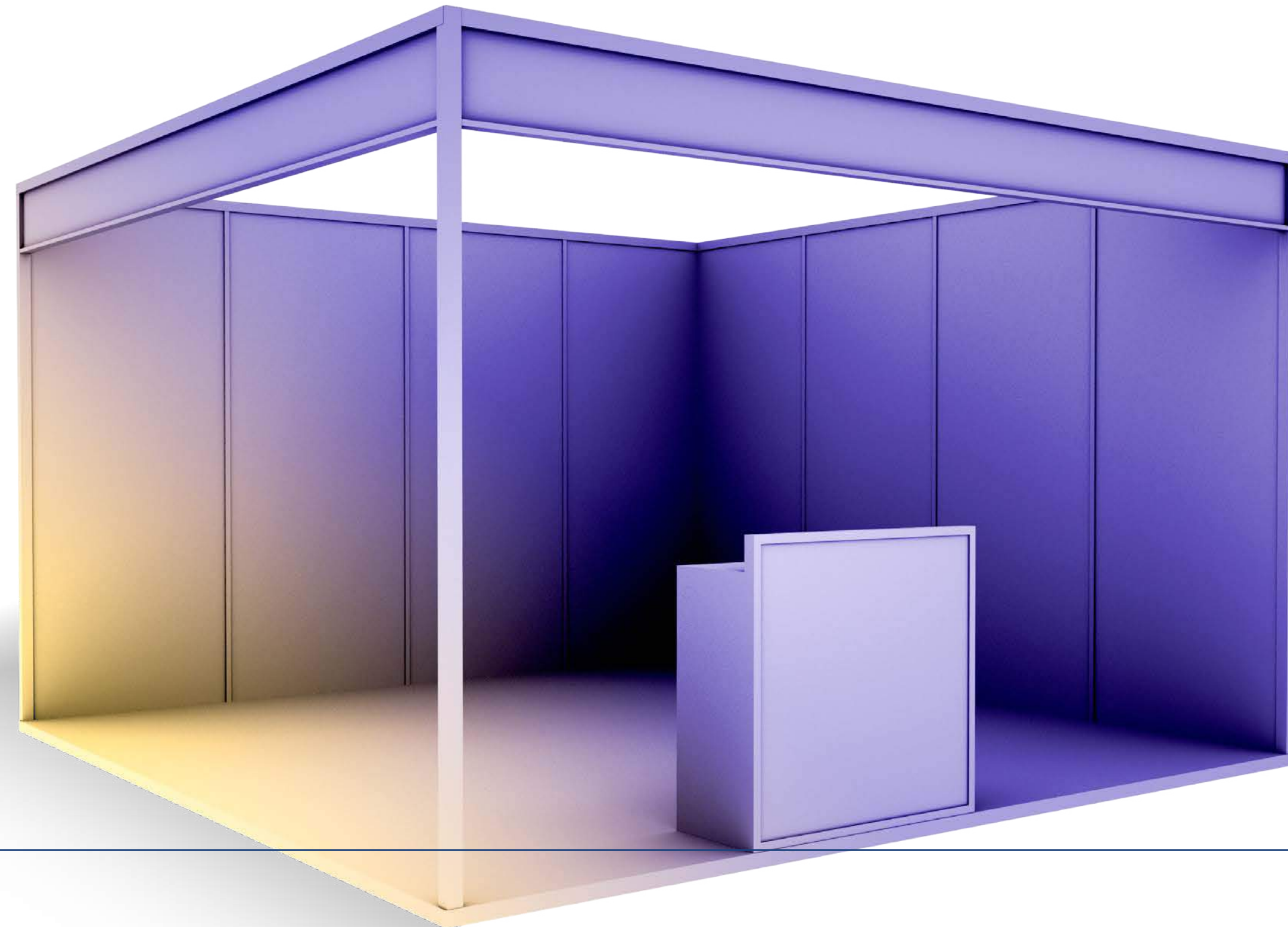
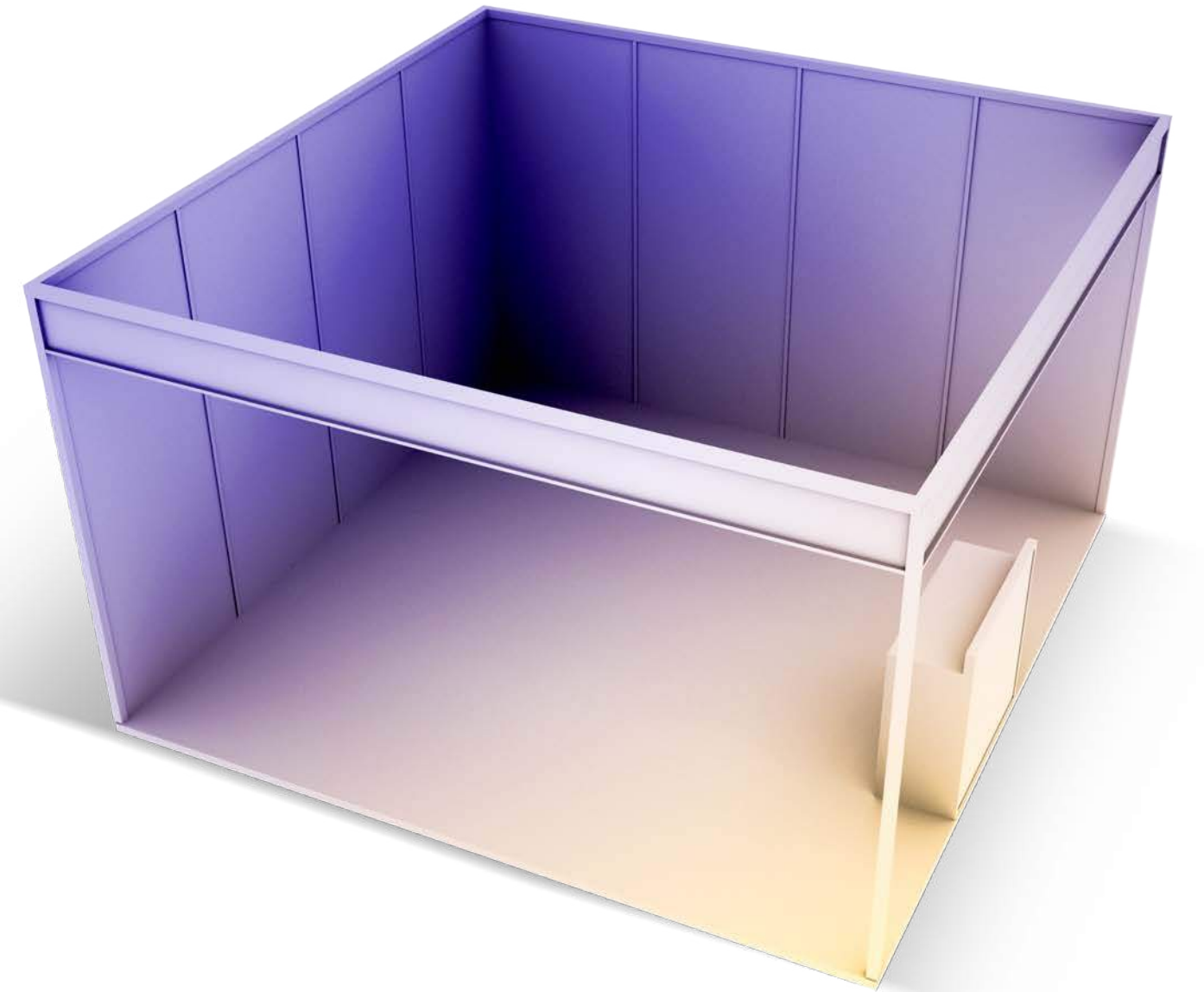

## Shell Scheme Stands

Great for SMEs, first time exhibitors, or exhibitors wishing to take a smaller stand.

**A cost-effective, off-the-shelf exhibiting solution.**

- Available from 9, 12, 15 or 18sqm sizes
- Customizable with graphics
- Furniture package included
- Premium package also available from 15sqm

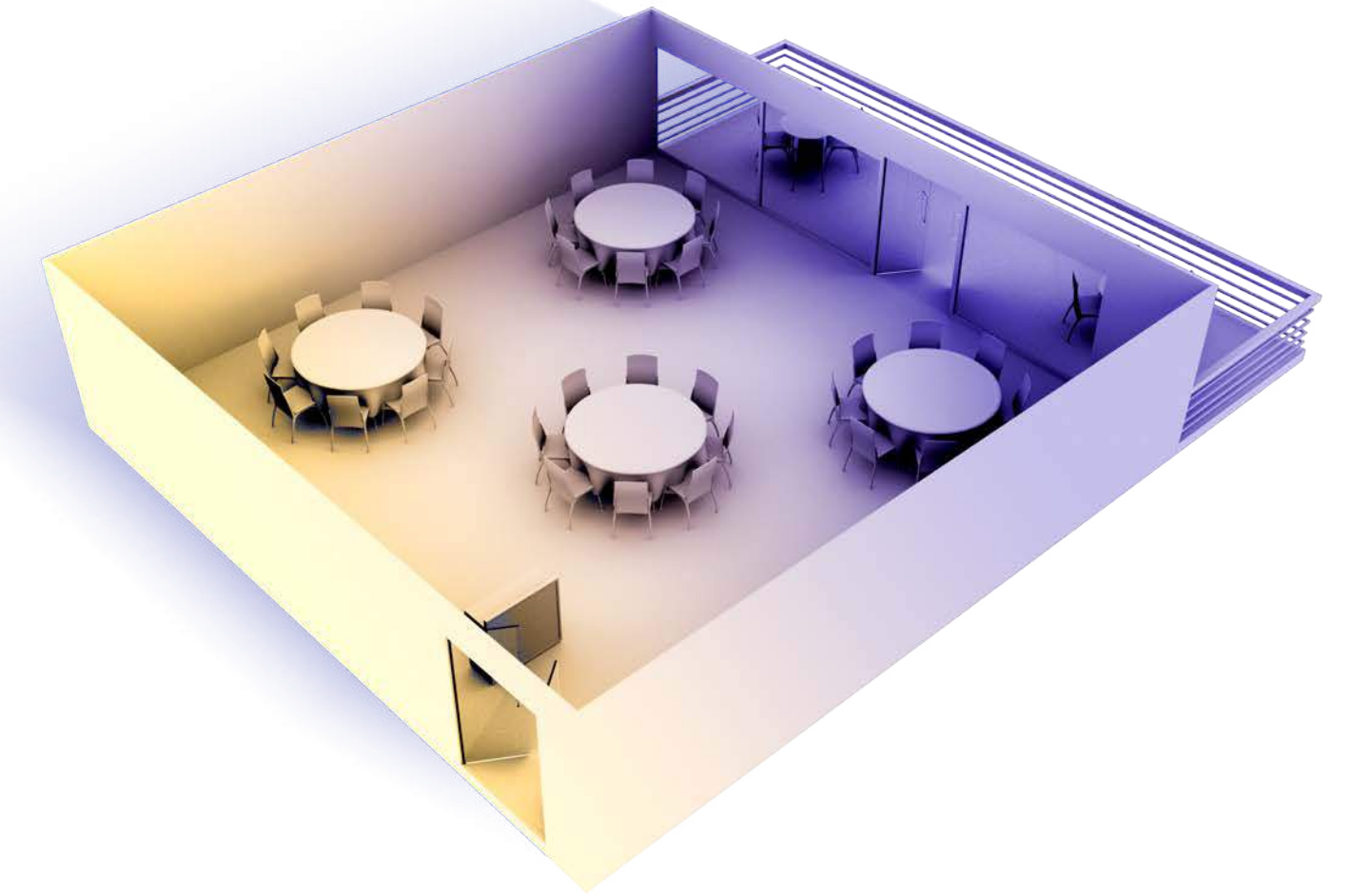
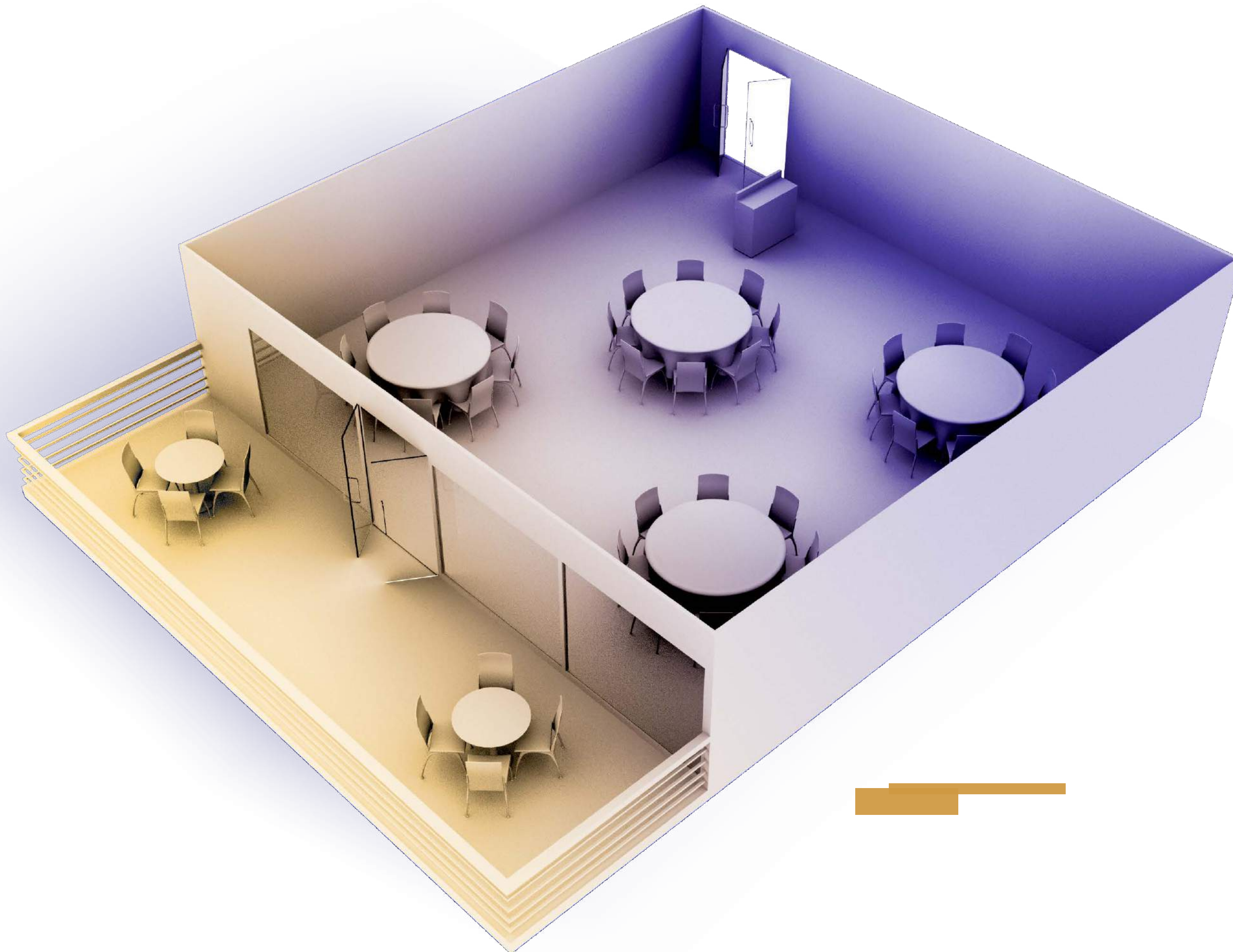

## Hospitality Suites

Great for hosting clients in an exclusive, VIP, turnkey environment, perfect for viewing the land and air displays and available to all exhibitors.

**Enjoy unrivalled views of the live displays in your own private hospitality environment.**

- A turnkey 100 sqm suite, including furniture and catering package
- All suites include a private balcony
- Single or double suites available

**Work with the World Defense Show sales team to customize your participation across a variety of exhibiting options tailored to your business needs.**

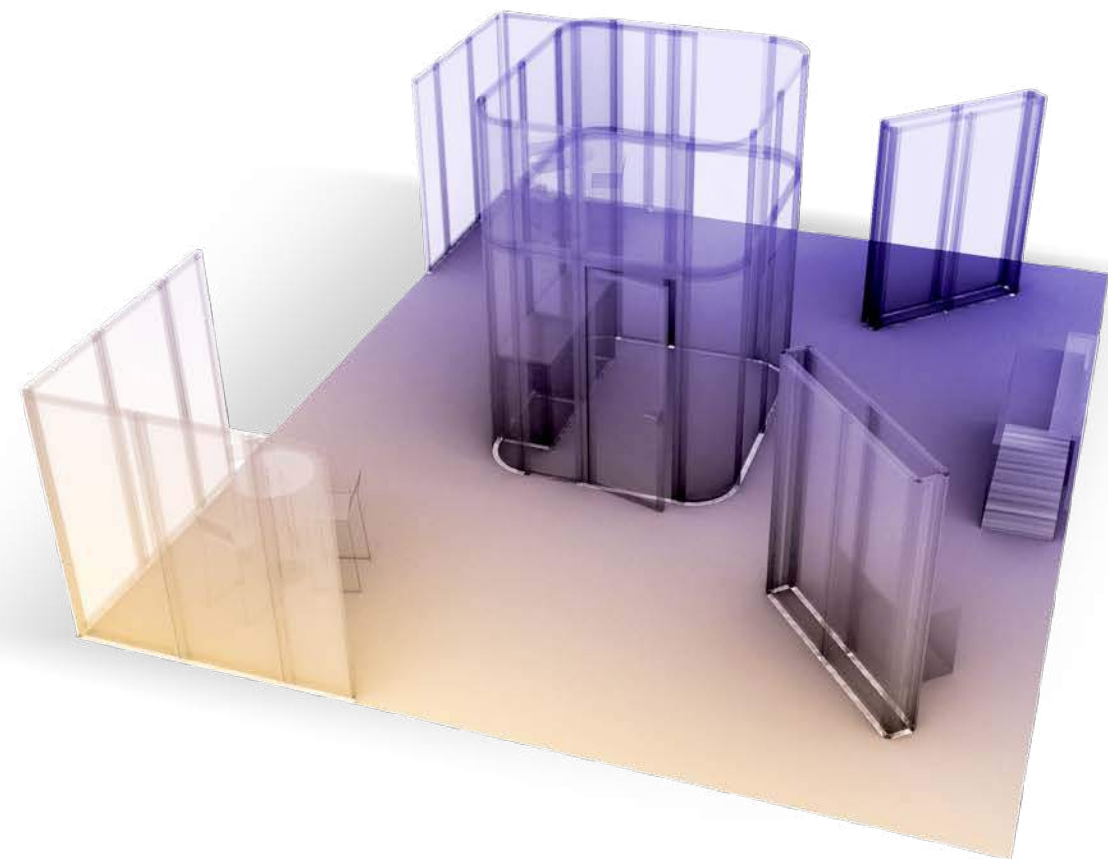
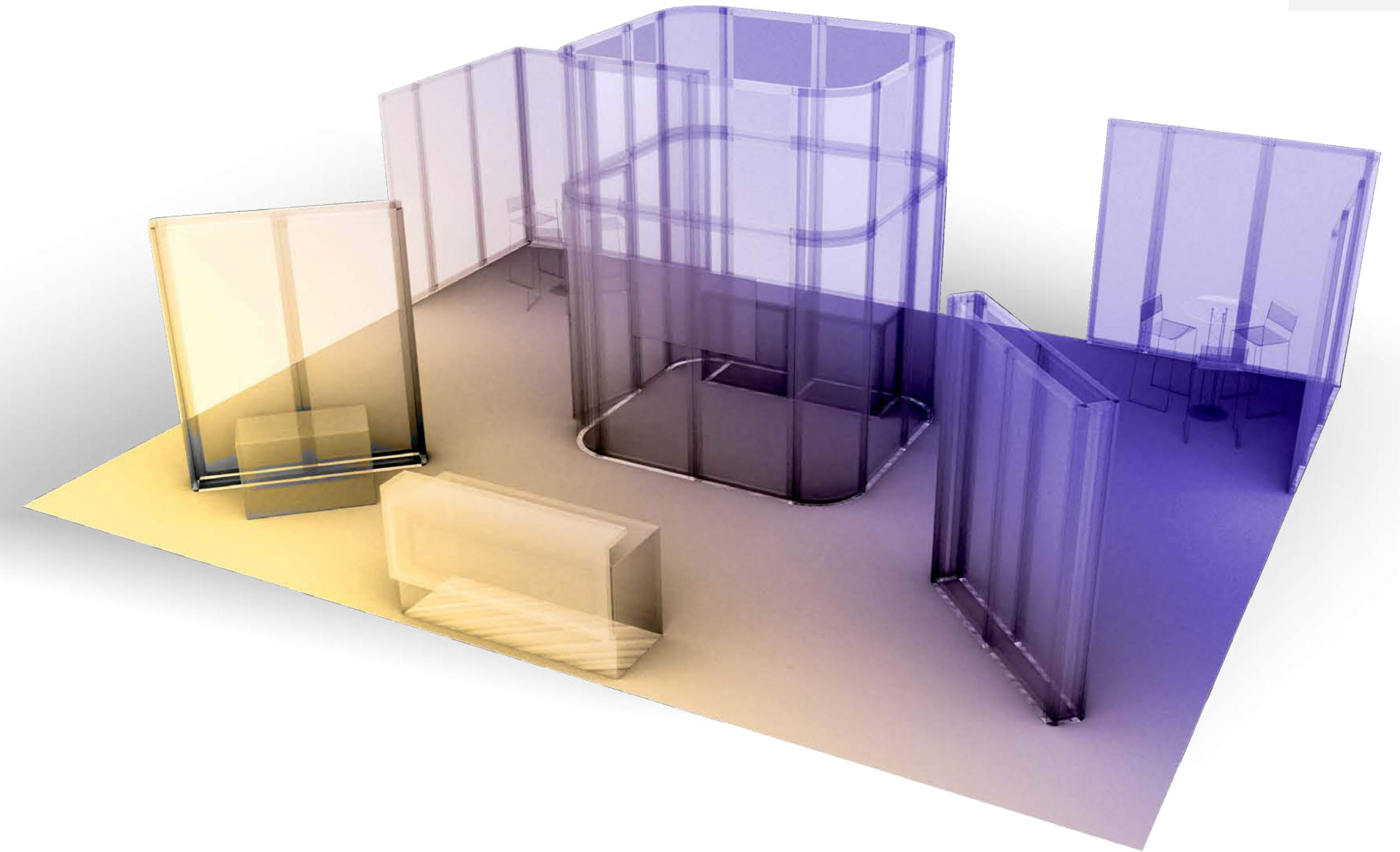

## Space Only

Great for national pavilions, product showcases, stands with integrated meeting rooms or on-stand hospitality.

**Maximize visibility with a high impact, bespoke built stand.**

- **Build your own bespoke stand using your own dedicated contractor**
- **Option to add additional upper level**
- **Min. requirement of 24 sqm**
- **Premium locations on offer**
- **Passes included**



## Outdoor Exhibiting Options

Live demonstration and static/land asset display.

- Minimum requirement of 15 sqm

For more information about this option please contact [sales@worlddefenseshow.com](mailto:sales@worlddefenseshow.com)



# Maximize Your Presence

**A diverse portfolio of unique sponsorship and advertising prospects are available to all exhibitors (from Primes to SMEs), designed to enhance your experience and exposure at World Defense Show.**

**Our tailored packages will help you meet your business' marketing objectives, grow your brand recognition globally and connect with your target audience across all areas of the defense industry.**



To enquire about sponsorship opportunities at World Defense Show 2022, please contact [sales@worlddefenseshow.com](mailto:sales@worlddefenseshow.com). Our sponsorship team look forward to supporting your business meet its goals and objectives through a tailored presence during the show.



# Contact Details

## The Team

Our team is highly specialized in events and exhibitions, offering a dedicated point of contact for each participant to truly immerse your business in the World Defense Show experience. We can tailor your package based on your specific business needs and will work with you every step of the way.

✉ [SALES@WORLDDEFENSESHOW.COM](mailto:SALES@WORLDDEFENSESHOW.COM)





✉ SALES@WORLDDEFENSESHOW.COM

🌐 WORLDDEFENSESHOW.COM

🐦 @WDS\_KSA

in WORLD DEFENSE SHOW

